

# Panasonic®

## IC Recorder

### Operating Instructions

Model No. **RR-QR400**  
**RR-QR200**  
**RR-QR100**



Model RR-QR200 is only for the U.S.A.

Before connecting, operating or adjusting this product, please read these instructions completely. Please keep this manual for future reference.



**Panasonic Consumer Electronics Company, Division of Matsushita Electric Corporation of America**

One Panasonic Way Secaucus, New Jersey 07094

<http://www.panasonic.com>

**Panasonic Sales Company, Division of Matsushita Electric of Puerto Rico, Inc. ("PSC")**

Ave. 65 de Infantería, Km. 9.5 San Gabriel Industrial Park, Carolina, Puerto Rico 00985

**Panasonic Canada Inc.**

5770 Ambler Drive, Mississauga, Ontario L4W 2T3

[www.panasonic.ca](http://www.panasonic.ca)

© 2001 Matsushita Electric Industrial Co., Ltd.  
Printed in Japan

RQT5967-P  
F0301KB0

## Dear customer

Thank you for purchasing this product. For optimum performance and safety, please read these instructions carefully.

### THE FOLLOWING APPLIES ONLY IN THE U.S.A.

#### CAUTION:

This equipment has been tested and found to comply with the limits for a Class B digital device, pursuant to Part 15 of the FCC Rules. These limits are designed to provide reasonable protection against harmful interference in a residential installation. This equipment generates, uses and can radiate radio frequency energy and, if not installed and used in accordance with the instructions, may cause harmful interference to radio communications. However, there is no guarantee that interference will not occur in a particular installation. If this equipment does cause harmful interference to radio or television reception, which can be determined by turning the equipment off and on, the user is encouraged to try to correct the interference by one or more of the following measures:

- Reorient or relocate the receiving antenna.
- Increase the separation between the equipment and receiver.
- Connect the equipment into an outlet on a circuit different from that to which the receiver is connected.
- Consult the dealer or an experienced radio/TV technician for help.

Any unauthorized changes or modifications to this equipment would void the user's authority to operate this device.

This device complies with Part 15 of the FCC Rules. Operation is subject to the following two conditions: (1) This device may not cause harmful interference, and (2) this device must accept any interference received, including interference that may cause undesired operation.

## Inserting the batteries

Long life alkaline batteries are recommended. If rechargeable batteries are to be used, rechargeable batteries manufactured by Panasonic are recommended.

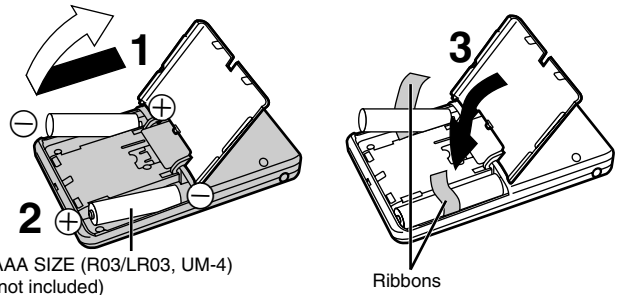

AAA SIZE (R03/LR03, UM-4)  
(not included)

Ribbons

#### Note

- Lay the ribbons under the batteries to make removal easier.
- Be sure the ribbons do not stick out when the lid is closed.

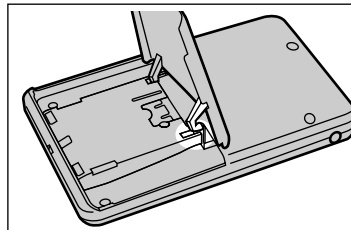

#### If the battery cover comes loose:

Push the cover's levers into the cutouts in the compartment as shown in the illustration.

#### After the batteries are inserted:

If the year starts flashing on the display, set the time so the unit can keep track of the time and date of recordings. For details see "Setting the time" (page 3).

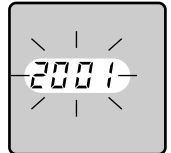

#### Note

Do not press the buttons while inserting the batteries. This may cause malfunction of the unit or its display.

## The battery indicator

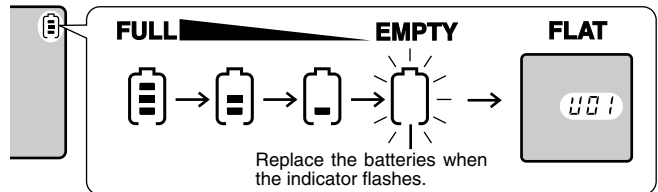

The flash memory preserves files and file information even if you remove the batteries or they go flat. Other memory items, however, revert to the factory settings if you take more than thirty seconds to replace the batteries or leave flat batteries in the unit for an extended period.

#### Note

- The battery indicator is not shown while the recorder is stopped.
- The unit does not work correctly if the battery cover is not closed completely.

## Hold function

This function prevents accidental operation.

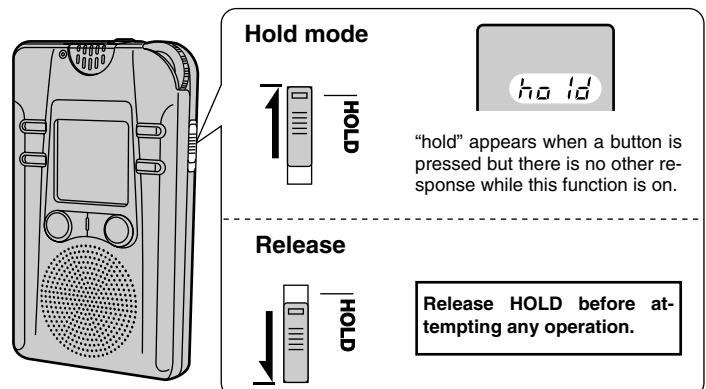

## Setting the time

Set the time after inserting the batteries so the times for the recordings are saved. Reset the clock regularly to maintain accuracy. (Monthly accuracy +/- 60 seconds.)

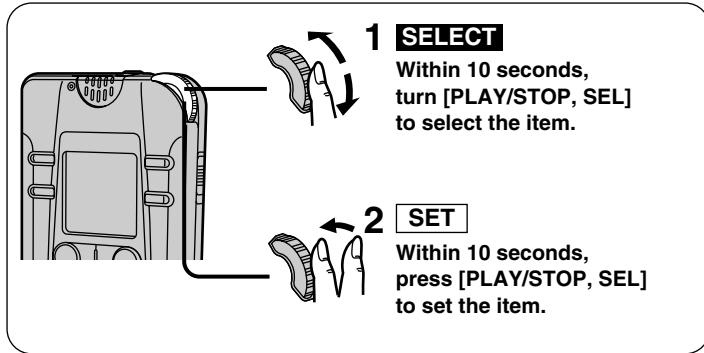

Repeat 1 and 2 to complete the settings.

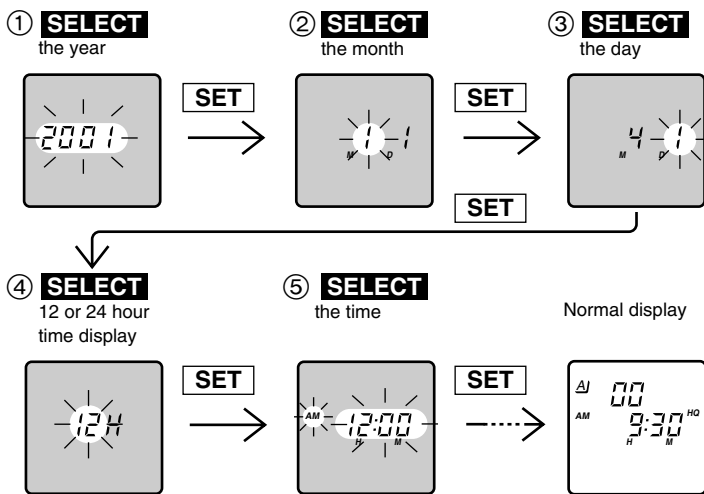

### Correcting the time settings

Press [MODE] to display the setting you want to correct, then [SELECT] and [SET] to change it.

## Changing modes

Each time [MODE] is pressed, the modes change in the following order.

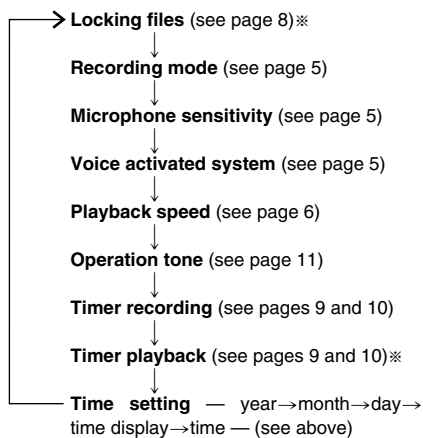
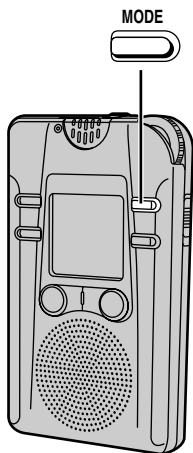

※Not displayed if there are no recordings.

### Note

- The original display is restored if an operation isn't performed within 10 seconds.
- Settings can be canceled by pressing [STOP].

## Recording

Files can be stored in separate "folders". Each folder can hold up to 99 files. Total recording time depends on the model and recording mode (see page 5, "Changing recording mode").

	Recording mode	Model		
		RR-QR400	RR-QR200	RR-QR100
Available recording time	LP (Long play)	420 minutes	200 minutes	100 minutes
	SP (Standard play)	131 minutes	65 minutes	31 minutes
	HQ (High quality)	65 minutes	32 minutes	15 minutes
Folders		4 (A, B, C, D)		

### Note

- Total recording time is the combined time of all the folders.
- The recording mode is originally set to "HQ".
- The recording being made can be lost if the unit receives a shock (e.g. it is dropped), or if the batteries and cover come loose.
- Leave VAS (page 5) off when recording important files.

### To pause recording:

Press and hold [•REC, •PAUSE].

The recording indicator flashes. Press again to resume recording.

### To record through the external microphone:

Plug the external microphone (not included) into the [MIC] jack. Then follow the steps 1-3 as illustrated above.

You can use a condenser microphone with or without built-in power supply. Plug type: 3.5 mm (1/8 in.) monaural

### To check available recording time:

Press [MODE] while recording. Press again to restore the display.

This display also appears when there is about 10% of the total recording time left. Press [MODE] to show the normal recording display for about 3 seconds.

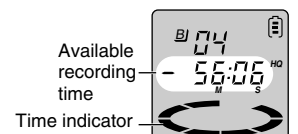

e.g. Display for [RR-QR400]

### Recording time displays

The display shows minutes and seconds.

[RR-QR400] : The display shows hours and minutes when the length of recording and remaining recording time are 300 minutes or longer.

The time indicator is a rough guide to the remaining recording time. The sections disappear as available time reduces and the last section flashes when there is about 10 percent left.

"FULL" is displayed when there is no time or file numbers left. Erase unnecessary files to continue recording.

## ■ Changing recording mode

Three modes can be selected. The mode is originally set to HQ ("HI").

- 1 Press [MODE] several times until the recording mode display is displayed.

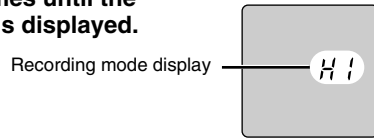

- 2 Within 10 seconds, turn [PLAY/STOP, SEL] to select the required mode.

Recording mode changes the total recording time.

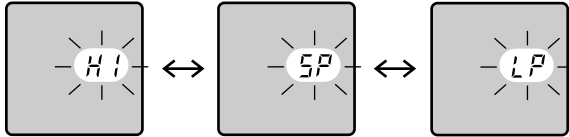

High quality mode

Standard play mode

Long play mode

- 3 Within 10 seconds, press [PLAY/STOP, SEL].  
The mode is selected.

### Note

"HQ" lights in other displays to indicate you have selected high quality mode.

## ■ Preventing unnecessary recording (Voice activated system: VAS)

VAS detects silence and pauses recording automatically. The voice mark flashes while VAS is waiting for a sound to record.

- 1 Press [MODE] several times until the voice mark is displayed.

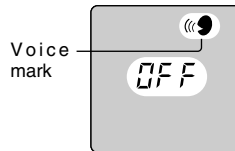

- 2 Within 10 seconds, turn [PLAY/STOP, SEL] to select "On".

- 3 Within 10 seconds, press [PLAY/STOP, SEL].  
VAS is now on.

### To turn the function off:

Select "OFF" in step 2 and press [PLAY/STOP, SEL].

## ■ Changing microphone sensitivity

Two levels of microphone sensitivity can be selected. The level is originally set to "H".

- 1 Press [MODE] several times until the microphone sensitivity display is displayed.

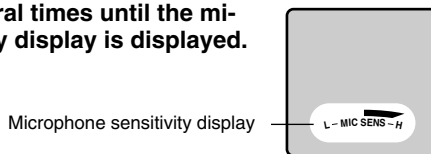

- 2 Within 10 seconds, turn [PLAY/STOP, SEL] to select the required level of sensitivity.

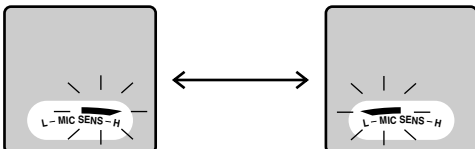

High: Relatively soft sounds are recorded.

Low: Only relatively louder sounds are recorded. Use when recording close to the mouth.

- 3 Within 10 seconds, press [PLAY/STOP, SEL].  
The level is selected.

### Note

Microphone sensitivity is shown only when sensitivity level is being changed. It is not shown constantly.

# Playback

- 1 Press [FOLDER] to select the folder containing the file you want to play.
- 2 Turn [PLAY/STOP, SEL] to select the file you want to play.  
Information about the selected file appears in the following order:  
① Date of recording  
② Time of recording  
③ Length of recording  
④ Number of files  
⑤ Normal display
- 3 Press [PLAY/STOP, SEL].  
Playback starts.
- 4 Adjust the volume.

Earphone jack

Play time

### To stop play

Press [STOP]. Press [PLAY/STOP, SEL] to resume play from you stopped.

### Other methods of playback

Use [PLAY/STOP, SEL].

To stop playback		Press during play. Press again to resume playback.
To move to other files during play		Turn slowly. Return to the beginning of the file by turning backward. Turn again within 3 seconds to move to the previous file.
Cue and review		Turn quickly during play. You can cue and review not only within a file, but the previous and the following files as well.

### Note

Volume may be changed after cueing, reviewing, stopping and dividing files.

### ■ To check the remaining playback time:

Press [MODE] during play.

Press again to restore the display.

#### Time indicator:

The sections disappear clockwise to indicate remaining playback time.

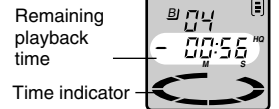

### ■ To listen to the first few seconds of each file (Intro-scan)

Press and hold [PLAY/STOP, SEL] while stopped for a moment.

The first 5 seconds of each file are played, in order, beginning with the first file. If you want to listen to a file in full, press [PLAY/STOP, SEL] while it is playing.

### ■ To change playback speed

Three playback speeds can be selected. The speed is originally set to normal.

- 1 Press [MODE] several times until the playback speed display is displayed.

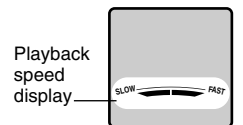

- 2 Within 10 seconds, turn [PLAY/STOP, SEL] to select the speed.

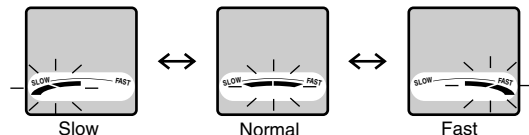

- 3 Within 10 seconds, press [PLAY/STOP, SEL].  
The speed is selected.

### For your reference

Press and hold [STOP] to restore normal playback speed.

### ■ Using earphone (not included)

Use a monaural type if you want to listen with an earphone.

Insert the earphone plug into the earphone jack. Sound will not be heard from the speaker.

Plug type: 3.5 mm (1/8 in.) monaural

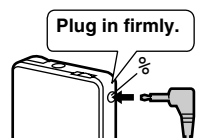

## Dividing files

You can divide a file into two at a point you choose. This allows you to extract the important parts of a recording to save.

### Preparation:

Select the folder and the file you want to divide. (page 6, steps 1-2)

**1 Press [PLAY/STOP, SEL] to start playback of the file.**

**2 Press [DIVIDE] at the point you want to divide the file.**

The number of the file flashes.

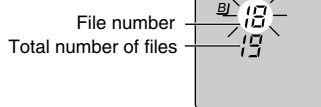

**3 Within 10 seconds, press and hold [DIVIDE].**

The file is divided.

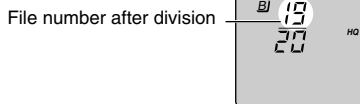

The file numbers after the divided file increase by one. Play is ready to start from the beginning of the latter of the two files created by this operation.

### Note

- You cannot divide a file if a folder already has 99 files.
- You may not be able to divide recordings less than one second.
- There may be a slight difference between the recording start time display for the files after division and the actual recording start time. The recording start time is intended to serve as a general guide only.
- The total time may not agree with the original recording time if a file is divided into many different files.

## Moving files

You can move a file to a different folder. This allows you to categorize files and save them together.

### Preparation:

Select the folder and the file you want to move. (page 6, steps 1-2)

**1 Press [PLAY/STOP, SEL] to start playback of the file.**

**2 Press [FOLDER] to select the folder you want to move the file to.**

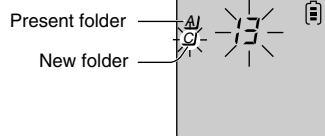

**3 Within 10 seconds, press [PLAY/STOP, SEL].**

The file moves to the end of the selected folder.

## Erasing files

Files can either be erased one by one or all at once. ERASE mode cannot be selected while an empty folder is selected. Erased files cannot be recalled.

### Preparation:

Select the folder first to erase individual files or folders. (page 6, step 1)

**1 Press and hold [ERASE] while stopped or during play.**

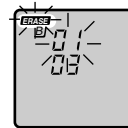

**2 Within 10 seconds, turn [PLAY/STOP, SEL] to select the file you want to erase.**

The display changes in the following order:

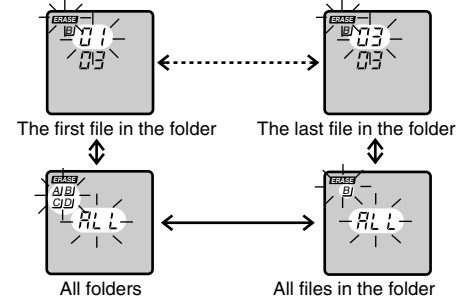

**3 Within 10 seconds, press [ERASE].**

The selected file is erased.

### Note

- Locked files will not be erased (see below).
- Total recording time can be reduced after erasing a number of files. Remedy this by erasing all the folders occasionally.
- You cannot erase files being played slow or fast.

## Erasure prevention

Lock individual recordings to avoid accidentally erasing them.

### Preparation:

Select the folder containing the file you want to lock. (page 6, step 1)

**1 Press [MODE] until "LOCK" flashes.**



**2 Within 10 seconds, turn [PLAY/STOP, SEL] to select the file.**

**3 Within 10 seconds, press [PLAY/STOP, SEL].**

The file is locked and "LOCK" is displayed until canceled.

### To unlock:

- 1 Select the locked file.
- 2 Repeat steps 1 and 3 for each file.

## Timer recording and playback

### ■Timer recording

Recording can be set to start and finish at set times. You must set the current time (see page 3).

Preparation:

Select the folder to record into. (page 6, step1)

- 1** Press [MODE] several times until the timer recording display is displayed.

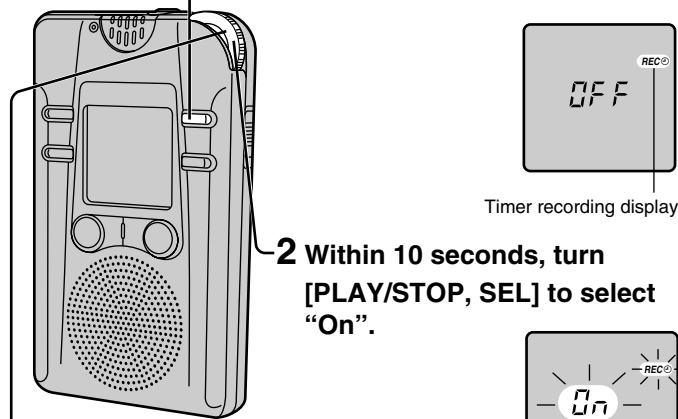

- 2** Within 10 seconds, turn [PLAY/STOP, SEL] to select "On".

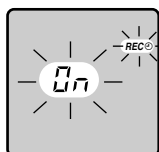

- 3** Set the times.

- ① Within 10 seconds, press [PLAY/STOP, SEL].  
The start time flashes.

- ② Within 10 seconds, turn [PLAY/STOP, SEL] to change the start time.

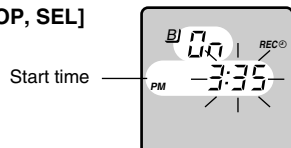

- ③ Within 10 seconds, press [PLAY/STOP, SEL].  
The start time is set and the finish time flashes.

- ④ Within 10 seconds, turn [PLAY/STOP, SEL] to change the finish time.

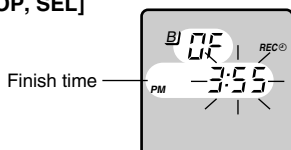

- ⑤ Within 10 seconds, press [PLAY/STOP, SEL].  
The display changes in the following order indicating completion of the settings.  
Recording start time → Recording finish time → Current number of files → Normal display

### ■Timer playback

Playback can be set to start at set time. You must set the current time (see page 3).  
Timer playback cannot be selected while an empty folder is selected.

Preparation:

Select the folder and the file you want to play.  
(page 6, steps1-2)

- 1** Press [MODE] several times until the timer play display is displayed.

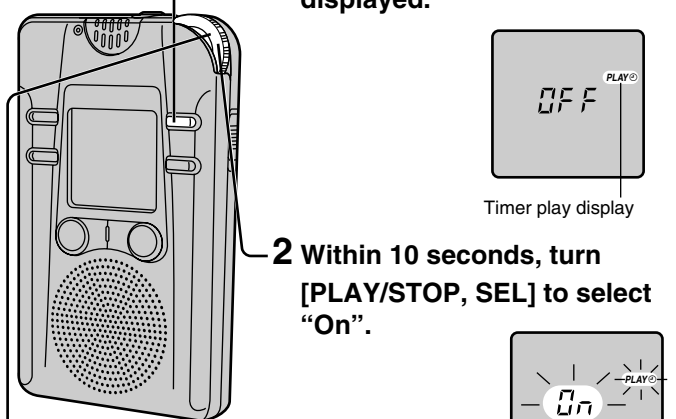

- 2** Within 10 seconds, turn [PLAY/STOP, SEL] to select "On".

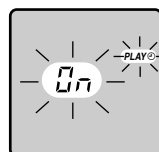

- 3** Set the times.

- ① Within 10 seconds, press [PLAY/STOP, SEL].  
The start time flashes.

- ② Within 10 seconds, turn [PLAY/STOP, SEL] to change the start time.

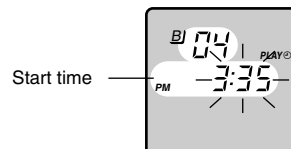

- ③ Within 10 seconds, press [PLAY/STOP, SEL].

The start time is set.  
The display changes in the following order indicating completion of the settings.  
Playback start time → Selected file number → Normal display

The timer playback stops automatically.

The timer indicators (REC and PLAY) light to show which timer is set and flash when the timer is operating.

#### To cancel the timer:

Select "OFF" in step 2 and press [PLAY/STOP, SEL].

#### To check the timer settings:

Press [MODE] several times until the timer display is displayed. The display will then change to show the following automatically.

Timer recording: Start time, finish time, folder the file will enter.

Timer playback: Start time, folder and file to be played.

#### Note

- The two timers cannot be used together. The timer set last is activated.
- The timers can only be set within a single twenty-four hour period. The recording timer can only be set if there is one minute or more of available recording time.
- If you make recordings before timer recording begins, be aware that the time available is reduced. The timer recording can only continue as long as the available time allows.
- If VAS is left on during timer recording, the recording may be shorter than the set time.
- The timer settings are canceled if the clock is cleared (i.e. the batteries are removed from the battery compartment).

## The operation tone

The operation tone can be turned on and off. The tone is originally set to "On".

- 1 Press [MODE] several times until "bEEP" is displayed.**

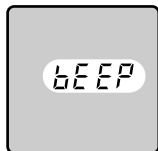

- 2 Turn [PLAY/STOP, SEL] to select "On" or "OFF".**

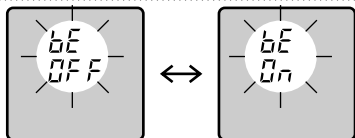

- 3 Within 10 seconds, press [PLAY/STOP, SEL].**  
A tone sounds each time an operation is performed if you select "On".

## Care and Use

### Unit

- Avoid using or placing this unit near sources of heat. Do not leave it in an automobile exposed to direct sunlight for a long period of time with the doors and windows closed.
- To avoid product damage, do not expose this product to rain, water or other liquids.
- Do not keep this unit and magnetized cards (bank cards, commuter passes, etc.) close together.
- The speaker does not have magnetic shielding. Do not place it near televisions, personal computers or other devices easily influenced by magnetism.

### Dry cell battery

- Align the poles (+ and -) properly when inserting the batteries.
- Do not mix old and new batteries or different types of batteries.
- Do not recharge ordinary dry cell batteries.
- Remove the batteries if the unit is not to be used for a long time.
- Do not use the batteries if the covering has been peeled off.

Mishandling of batteries can cause electrolyte leakage which can damage items the fluid contacts and may cause a fire. If electrolyte leaks from the batteries, consult your dealer. Wash thoroughly with water if electrolyte comes in contact with any part of your body.

### Listening caution



Do not play your headphones or earphones at a high volume. Hearing experts advise against continuous extended play.

If you experience a ringing in your ears, reduce volume or discontinue use. Do not use while operating a motorized vehicle. It may create a traffic hazard and is illegal in many areas.

You should use extreme caution or temporarily discontinue use in potentially hazardous situations.

Even if your headphones or earphones are the open-air type designed to let you hear outside sounds, don't turn up the volume so high that you can't hear what's around you.

Sound can be deceiving. Over time your hearing "comfort level" adapts to higher volumes of sound. So what sounds "normal" can actually be loud and harmful to your hearing.

Guard against this by setting your equipment at a safe level BEFORE your hearing adapts.

To establish a safe level:

- Start your volume control at a low setting.
- Slowly increase the sound until you can hear it comfortably and clearly, and without distortion.

Once you have established a comfortable sound level:

- Set the dial and leave it there.

## Product Service

Do not attempt to remove the cover(s) or repair the unit yourself. Refer servicing to qualified personnel only.

### Product information

For product service, product information or assistance with product operation, refer to the servicenter directory.

The serial number of this product can be found on the back of the cassette compartment cover or inside the battery compartment. Please note it in the space provided below and keep as a permanent record of your purchase to aid identification in the event of theft.

MODEL NUMBER \_\_\_\_\_  
SERIAL NUMBER \_\_\_\_\_

## Troubleshooting Guide

Before requesting service, make the below checks.

If you are in doubt about some of the check points, or if the remedies indicated in the chart do not solve the problem:

In the U.S.A., contact the Panasonic Customer Call Center at 1-800-211-7262, or e-mail [consumerproducts@panasonic.com](mailto:consumerproducts@panasonic.com), or web site (<http://www.panasonic.com>). In Canada, contact Panasonic Canada Inc. Customer Care Centre at 905-624-5505, or web site ([www.panasonic.ca](http://www.panasonic.ca)), or an authorized Servicentre nearest you.

Symptom	Checkpoints
Unit doesn't operate	<ul style="list-style-type: none"> <li>• Is HOLD on? (page 2)</li> <li>• Is the the battery cover properly closed?</li> </ul>
No sound from the speaker	<ul style="list-style-type: none"> <li>• Is earphone (not included) connected?</li> <li>• Is the volume turned down?</li> </ul>
When using earphone (not included), there is no sound or it is difficult to hear or there is noise	<ul style="list-style-type: none"> <li>• Is the earphone plug fully inserted?</li> <li>• Is the plug dirty? (Wipe away dirt on plug.)</li> </ul>
"U01" appears on the display	<ul style="list-style-type: none"> <li>• Have the batteries run down?</li> </ul>
Recording stops	<ul style="list-style-type: none"> <li>• Has VAS (page 5) functioned?</li> </ul>
Recording not made	<ul style="list-style-type: none"> <li>• Did the batteries or cover come loose during recording?</li> </ul>
The date of recording appears as "-- --"	<ul style="list-style-type: none"> <li>• Has the time been set? (The date of recording is not displayed unless the time has been set.)</li> </ul>
Playback speed is too fast or slow	<ul style="list-style-type: none"> <li>• Has playback speed been changed? (See page 6 to set to the required speed.)</li> </ul>
"FULL" appears when trying to make a recording	<ul style="list-style-type: none"> <li>• Have 99 files been recorded in the folder?</li> <li>• Has the recording time limit been made? – Erase unneeded files.(page 8)</li> </ul>
Cannot erase a folder or file	<ul style="list-style-type: none"> <li>• Have you selected an empty folder?</li> <li>• Is the file locked? (page 8)</li> </ul>
The clock flashes "12:00"	<ul style="list-style-type: none"> <li>• Set the clock. (page 3)</li> </ul>

## Maintenance

### If the surfaces are dirty

To clean this unit, wipe with a soft, dry cloth.

- Never use alcohol, paint thinner or benzine to clean this unit.
- Before using chemically treated cloth, read the instructions that came with the cloth carefully.

## Specifications

<b>Power requirement:</b>	DC 3 V 2 AAA SIZE (R03/LR03, UM-4) BATTERIES
<b>Power output:</b>	200 mW (max.)
<b>Frequency response:</b>	300 Hz – 4,300 Hz (HQ mode)
<b>S/N:</b>	38 dB (HQ mode)
<b>Jack:</b>	
<b>Output jack;</b>	Earphone, 3.5 mm (1/8 in.); 3.6 mW 16 Ω
<b>Input jack;</b>	Mic, 3.5 mm (1/8 in.); 0.56 mV Plug in power
<b>Speaker:</b>	28 mm (1 3/32 in.) 8 Ω
<b>Dimensions (W×H×D):</b>	
<b>Max dimensions;</b>	56.0 × 91.5 × 13.7 mm (2 3/16 × 3 5/8 × 1/2 in.)
<b>Cabinet dimensions;</b>	55.0 × 91.0 × 12.8 mm (2 3/16 × 3 5/16 × 1/2 in.)
<b>Mass:</b>	
<b>with batteries;</b>	About 64 g (2.3 oz.)
<b>without batteries;</b>	About 44 g (1.6 oz.)
<b>Operational temperature range:</b>	0 °C – 40 °C (32 °F – 104 °F)
<b>Battery life:</b>	
[When used at 25 °C (77 °F) and on a flat and stable surface]	

Batteries	Playback	Recording
Panasonic alkaline batteries	About 15 hours	About 30 hours

- The battery life may be less depending on the operating conditions.

### Note:

- Specifications are subject to change without notice.
- Mass and dimensions are approximate.

## Features

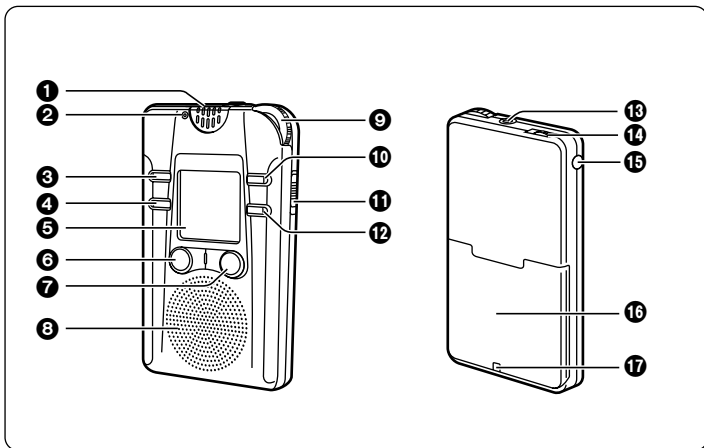

- 1 Built-in microphone (MIC)
- 2 Recording indicator
- 3 Divide button (DIVIDE)
- 4 Erase button (ERASE)
- 5 Display screen
- 6 Stop button (STOP)
- 7 Recording, pause button (•REC, ■ PAUSE)
- 8 Speaker
- 9 Play/stop, select dial (PLAY/STOP, SEL)
- 10 Mode button (MODE)
- 11 Hold switch (HOLD)
- 12 Folder button (FOLDER)
- 13 Microphone jack (MIC)
- 14 Volume control (VOL)
- 15 Earphone jack (🎧)
- 16 Battery cover
- 17 Hand strap hole

Panasonic Consumer Electronics Company, Division of Matsushita Electric Corporation of America  
One Panasonic Way,  
Secaucus, New Jersey 07094

ONLY FOR U. S. A.

Panasonic Sales Company, Division of Matsushita Electric Corporation of Puerto Rico, Inc.  
Ave. 65 de Infantería, Km. 9.5,  
San Gabriel Industrial Park,  
Carolina, Puerto Rico 00985

## Panasonic/Technics Audio Products Limited Warranty

Panasonic Consumer Electronics Company or Panasonic Sales Company (collectively referred to as "the warrantor") will repair this product with new or refurbished parts in the event of a defect in materials or workmanship, free of charge, in the U.S.A. or Puerto Rico as follows (all time periods start from the date of original purchase) :

AUDIO PRODUCTS—labor and parts for one (1) year.

ALL AUDIO RACKS(cabinets)—parts only 30 days.

TECHNICS STAND ALONE SPEAKERS, SUBWOOFER SPEAKERS—labor and parts for three (3) years.

USB READER-WRITER, PERSONAL COMPUTER CARD ADAPTERS—(when applicable)—exchange defective unit with a new or refurbished one for one (1) year.

ACCESSORIES—HEADPHONES, CARTRIDGES,

MICROPHONES, ADAPTERS—labor and parts for ninety (90) days.

RECHARGEABLE BATTERIES—(when applicable)—exchange defective item for new one for ten (10) days. Non-rechargeable batteries are not warranted.

SD MEMORY CARDS, RECHARGEABLE BATTERY PACKS—(when applicable)—exchange defective item for new one for ninety (90) days. Non-rechargeable battery packs are not warranted.

Carry-in or mail-in service in the U.S.A. can be obtained during the warranty period by contacting a Panasonic Services Company (PASC) Factory Servicenter listed in the Servicenter Directory. Or call toll free, 1-800-211-7262 to locate a PASC authorized Servicenter. Carry-in or mail-in service in Puerto Rico can be obtained during the warranty period by calling the Panasonic Sales Company telephone number listed in the Servicenter Directory.

This warranty is extended only to the original purchaser. A purchase receipt or other proof of date of original purchase will be required before warranty service is rendered.

This warranty only covers failures due to defects in materials and workmanship which occur during

normal use and does not cover normal wear to the stylus (when applicable) or a dealer installed cartridge or stylus. The warranty does not cover damages which occur in shipment or failures which are caused by products not supplied by the warrantor, or failures which result from accident, misuse, abuse, neglect, mishandling, faulty installation, misapplication, set-up adjustments, maladjustment of consumer controls, improper operation or maintenance, improper antenna, inadequate signal reception or pick-up, alteration, modification, power line surge, improper voltage supply, lightning damage, commercial use, such as; hotel, office, restaurant, or other business or rental use of the product, or service by anyone other than a PASC Factory Servicenter or a PASC authorized Servicenter, or damage that is attributable to acts of God.

### LIMITS AND EXCLUSIONS

There are no express warranties except as listed above.

THE WARRANTOR SHALL NOT BE LIABLE FOR INCIDENTAL OR CONSEQUENTIAL DAMAGES RESULTING FROM THE USE OF THIS PRODUCT, OR ARISING OUT OF ANY BREACH OF THIS WARRANTY, INCLUDING WITHOUT LIMITATION, DAMAGE TO TAPES, RECORDS OR DISCS. ALL EXPRESS AND IMPLIED WARRANTIES, INCLUDING THE WARRANTIES OF MERCHANTABILITY, AND FITNESS FOR A PARTICULAR PURPOSE, ARE LIMITED TO THE APPLICABLE WARRANTY PERIOD SET FORTH ABOVE. Some states do not allow the exclusion or limitation of incidental or consequential damages, or limitations on how long an implied warranty lasts, so the above exclusions or limitations may not apply to you.

This warranty gives you specific legal rights and you may also have other rights which vary from state to state.

If a problem with this product develops during or after the warranty period, you may contact your dealer or Servicenter. If the problem is not handled to your satisfaction, then write to the Consumer Affairs Department at the company address indicated above.

If you ship the product

Carefully pack and send it prepaid, adequately insured and preferably in the original carton. Attach a postage-affixed letter, detailing the complaint, to the outside of the carton.

*Do NOT send the product to the Executive or Regional Sales offices. They are NOT equipped to make repairs.*

### Customer's Record

Model No. \_\_\_\_\_

Dealer's Name \_\_\_\_\_

Serial No. \_\_\_\_\_  
or \_\_\_\_\_

\_\_\_\_\_

Code No. \_\_\_\_\_

Dealer's Address \_\_\_\_\_

Date of Purchase \_\_\_\_\_

\_\_\_\_\_

ONLY FOR U.S.A.

**Panasonic**

**Technics**

**Quasar®**

*For Product Information, Operating Assistance, Literature Request, Dealer Locations, and all Customer Service inquiries please contact:*  
**1-800-211-PANA (7262), Monday–Friday 9 am–9 pm, Saturday–Sunday 9 am–7 pm, EST.**

**Web Site: <http://www.Panasonic.com>**  
**You can purchase parts, accessories or locate your nearest servicer by visiting our Web Site.**

**Accessory Purchases:**

**1-800-332-5368 (Customer Orders Only)**  
**Panasonic Services Company 20421 84th Avenue South, Kent, WA 98032**  
**(6 am to 5 pm Monday–Friday; 6 am to 10:30 am Saturday; PST)**  
**(Visa, MasterCard, Discover Card, American Express, Check)**

**Factory Servicenters Locations**

**CALIFORNIA**

6550 Katella Avenue  
Cypress, CA 90630

800 Dubuque Avenue  
S. San Francisco  
CA 94080

3878 Ruffin Road  
Suite A  
San Diego, CA 92123

**COLORADO**

1640 South Abilene Street  
Suite D  
Aurora, CO 80012

**FLORIDA**

3700 North 29<sup>th</sup> Avenue  
Suite 102  
Hollywood, FL 33020

**GEORGIA**

8655 Roswell Road  
Suite 100  
Atlanta, GA 30350

**ILLINOIS**

9060 Golf Road  
Niles, IL 60714

1703 North Randall Road  
Elgin, IL 60123  
(Pick-up/Drop-off only)

**MARYLAND**

62 Mountain Road  
Glen Burnie, MD 21061

**MASSACHUSETTS**

60 Glacier Drive  
Suite G  
Westwood, MA 02090

**MINNESOTA**

7850-12<sup>th</sup> Avenue South  
Airport Business Center  
Bloomington, MN 55425

**OHIO**

2236 Waycross Road  
Civic Center Plaza  
Forest Park, OH 45240

**PENNSYLVANIA**

2221 Cabot Blvd. West  
Suite B  
Langhorne, PA 19047

**TEXAS**

13615 Welch Road  
Suite 101  
Farmers Branch  
TX 75244

**WASHINGTON**

20425-84<sup>th</sup> Avenue South  
Kent, WA 98032

**HAWAII**

99-859 Iwaiwa Street  
Aiea, Hawaii 96701  
Phone (808) 488-1996  
Fax (808) 486-4369

**Service in Puerto Rico**

**Matsushita Electric of Puerto Rico, Inc. Panasonic Sales Company/Factory Servicer:**  
**Ave. 65 de Infanteria, Km. 9.5, San Gabriel Industrial Park, Carolina, Puerto Rico 00985**  
**Phone (787) 750-4300 Fax (787) 768-2910**